

Pinout for PDP-11/20, PDP-11/05
PDP-11/05: punt in Slot ...

Sheet: Switches

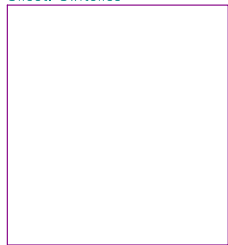

File: switches.sch

Sheet: LEDs



File: LEDs.sch

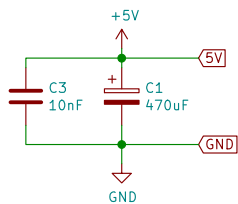

BV-X

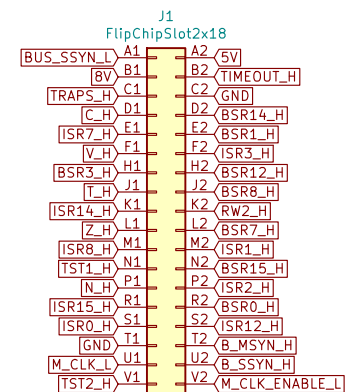

Sheet: /
File: km11.sch

Title: DEC KM11 DIAGNOSTIC BOARD

Size: A4
KiCad E.D.A. kicad (5.1.0)-1

Date:
Rev:
Id: 1/3

Switches idle or "OFF": 1-2 closed
 S1 "NO TIMEOUT"
 S2 "M CLK ENABLE"
 S3 "BUS SSYN"
 S4 ""M CLK TOGGLE" (momentary action)

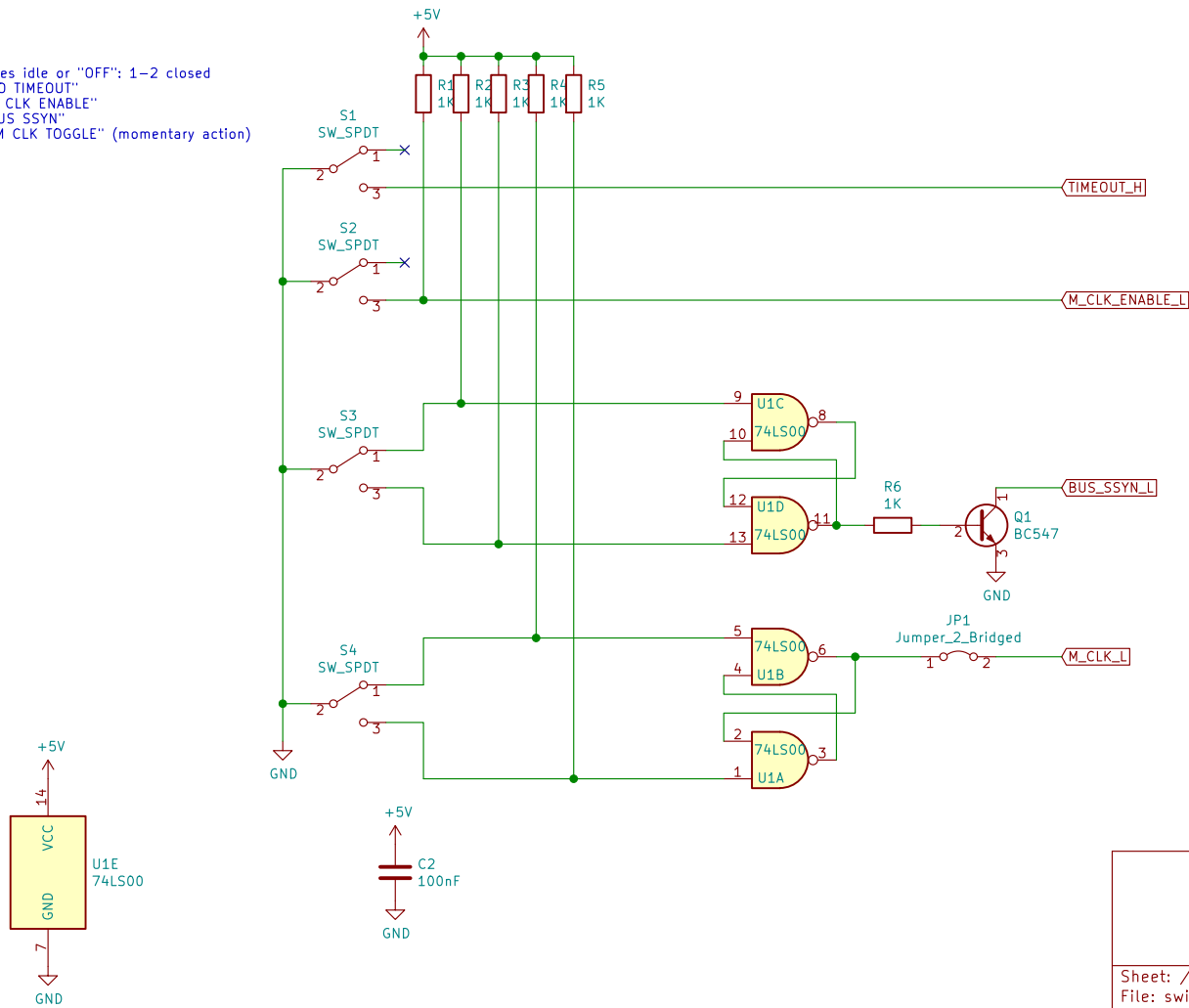

Sheet: /Switches/
 File: switches.sch

Title:

Size: A4
 KiCad E.D.A. kicad (5.1.0)-1

Date:

Rev:
 Id: 2/3

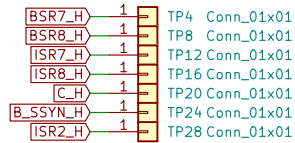
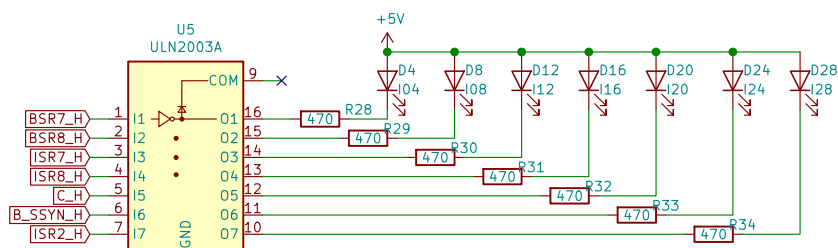
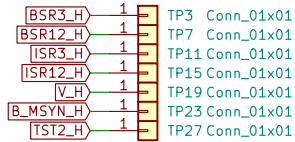
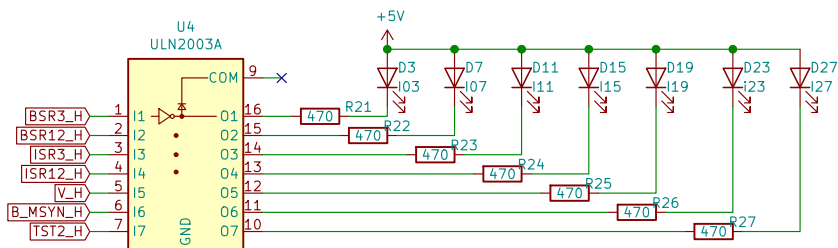
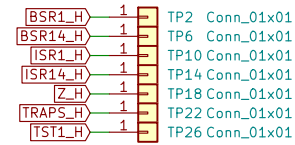
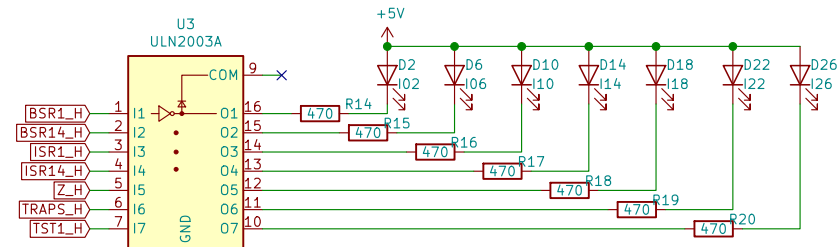
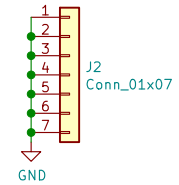
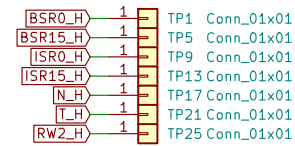
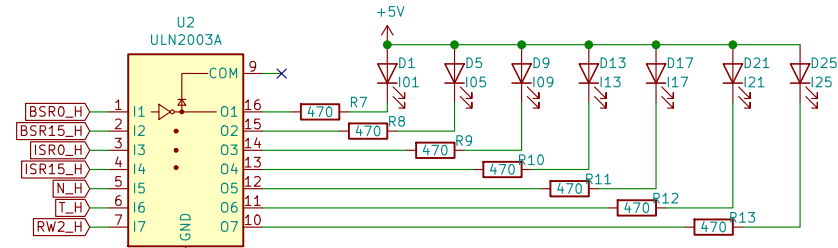

Sheet: /LEDs/
File: LEDs.sch

Title:

Size: A4
KiCad E.D.A. kicad (5.1.0)-1

Date:

Rev:
Id: 3/3